

# AVANTGARDE-200

## AV4-20

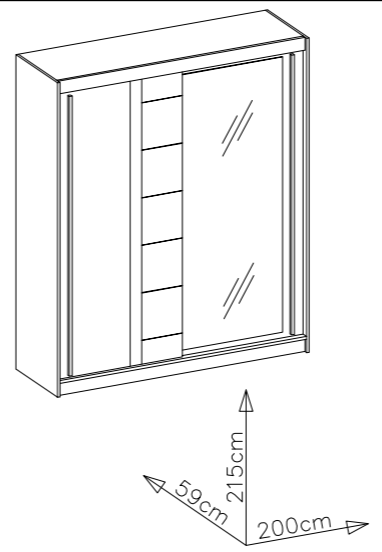

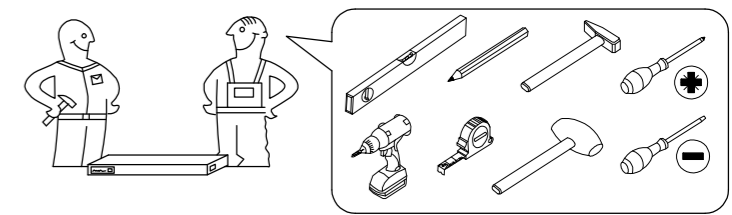

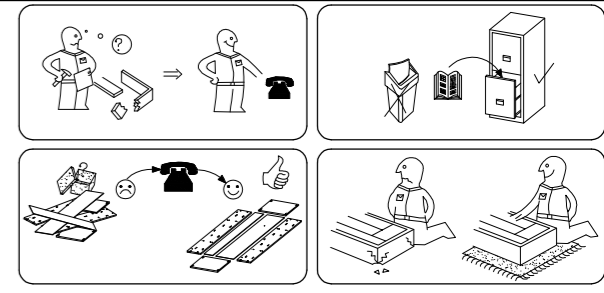



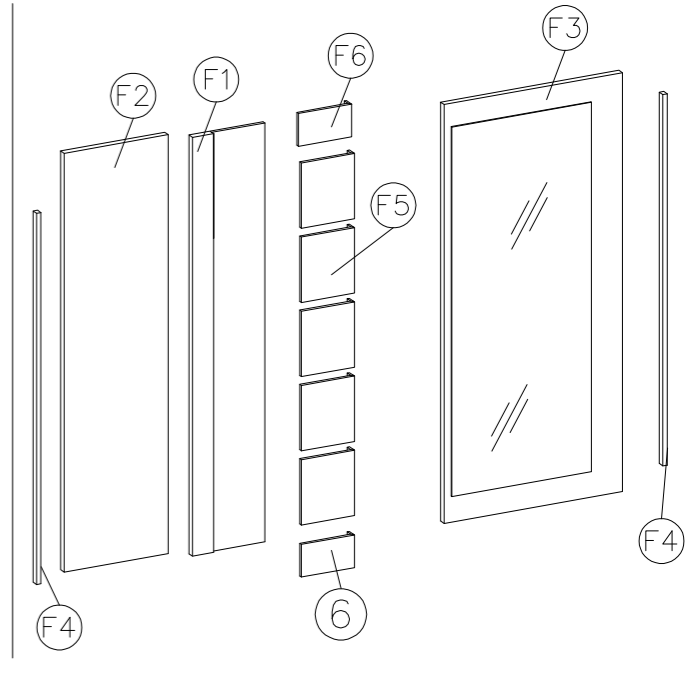
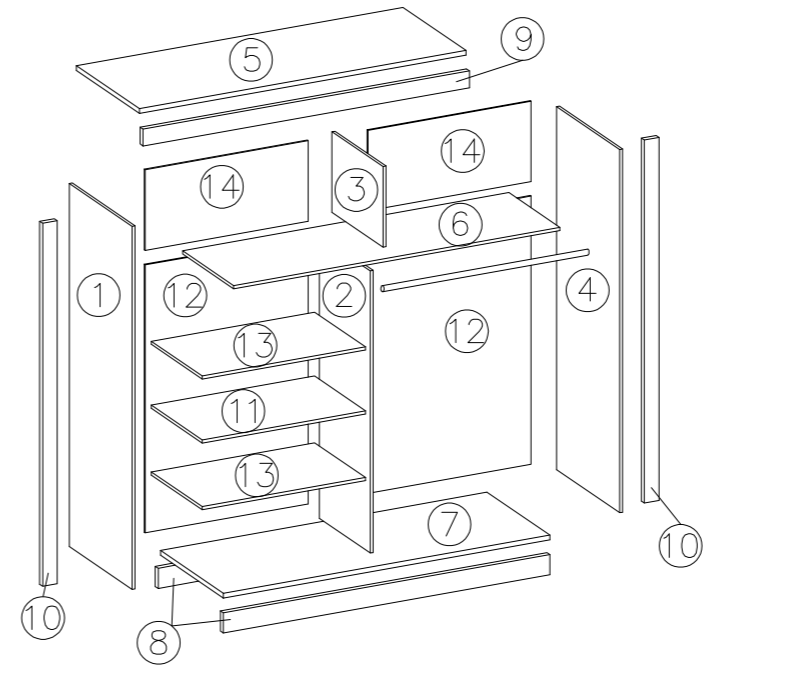
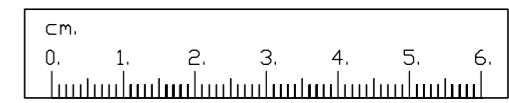























#	XX-200	dim.	p.
1	4208AS	2150x584	1
2	4203AS	1643x480	1
3	4212AS	358x480	1
4	4209AS	2150x584	1
5	4200AS	1968x563	1
6	4201AS	1968x480	1
7	4202AS	1968x580	1
8	4206AS	1968x100	2
9	4207AS	1968x70	1
10	4213AS	2150x22	2
11	5786a	684x480	1
12	5791	1665x743	2
13	5785a	684x475	2
14	5792	382x743	2



AV2-20					
#	L	W	T	Q	Col.No
F1	440	1982	16	1	3
F2	570	1982	16	1	3
F3	1010	1982	16	1	3
F4	1933	20	16	2	3
F5	385	310	10	5	3
F6	385	190	10	2	3



 A	 B	 O11	 E1	 P1	 Z1
32	24	2	24	2	1
 O	 F8	 J4	 F1	 C1	 Y1
1	24	8	10	4	2
 O3	 O10	 F10	 Y3	 O12	 P21
12	2	100	8	1	8

 A1	 C	 E	 D2	 P18
6	12	12	6	10
 K5	 K6	 P4	 P23	 W5
4	4	12	16	2
 P13	 P8			
28	4			

1	ø8x30mm	L-1468	
	A	C1	Y1
	8	4	2
	4.0x16mm	L-1968	
	Y3	P21	Y1
	8	8	2

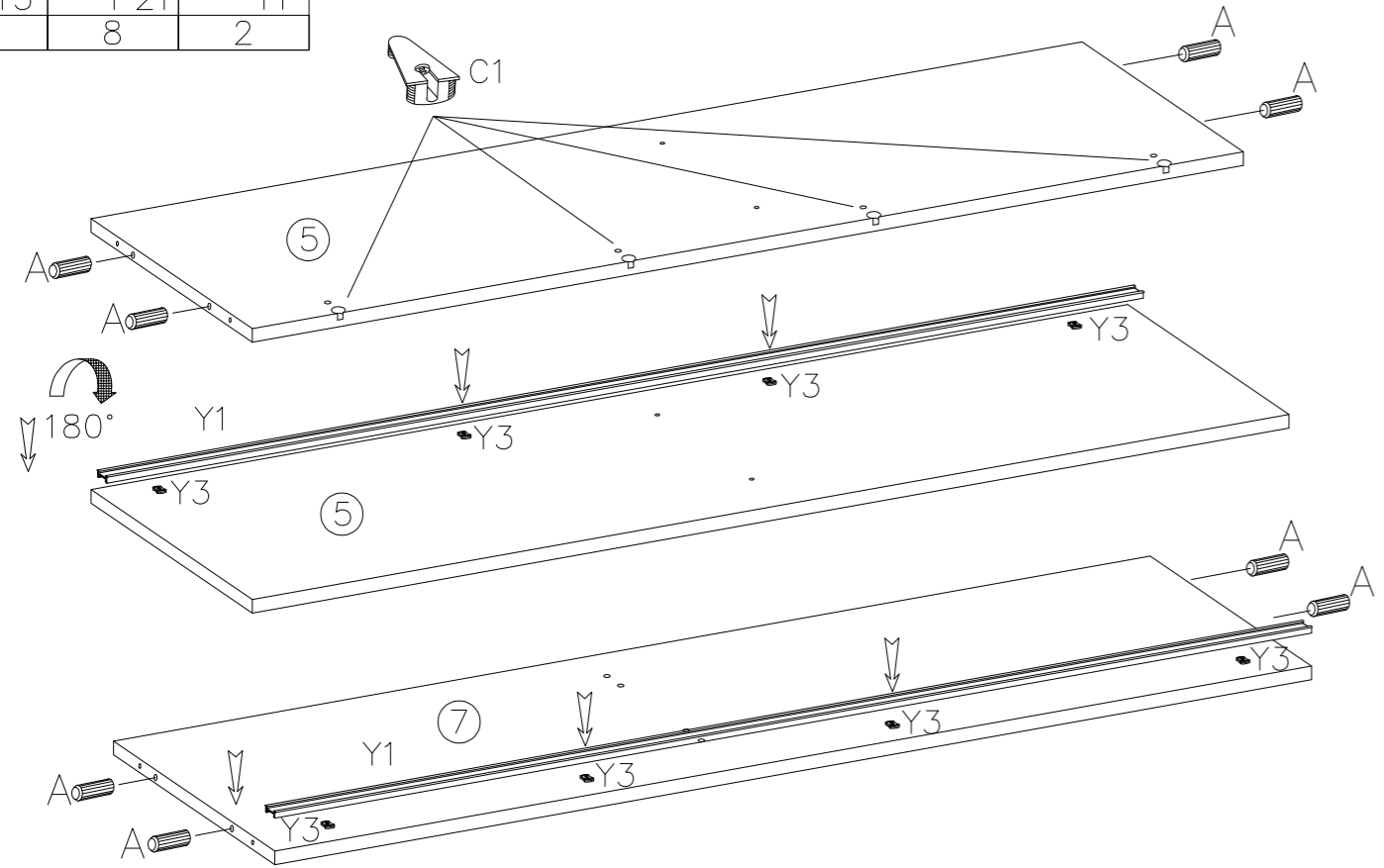
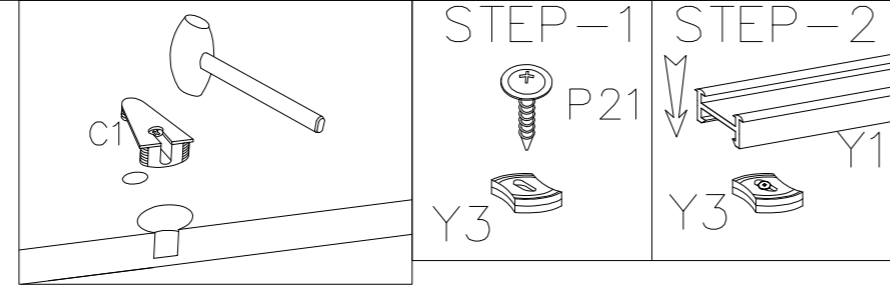

13

L-46	D2
6	ø8x40mm
A1	
6	ø15/12mm
C	
12	
E	
12	

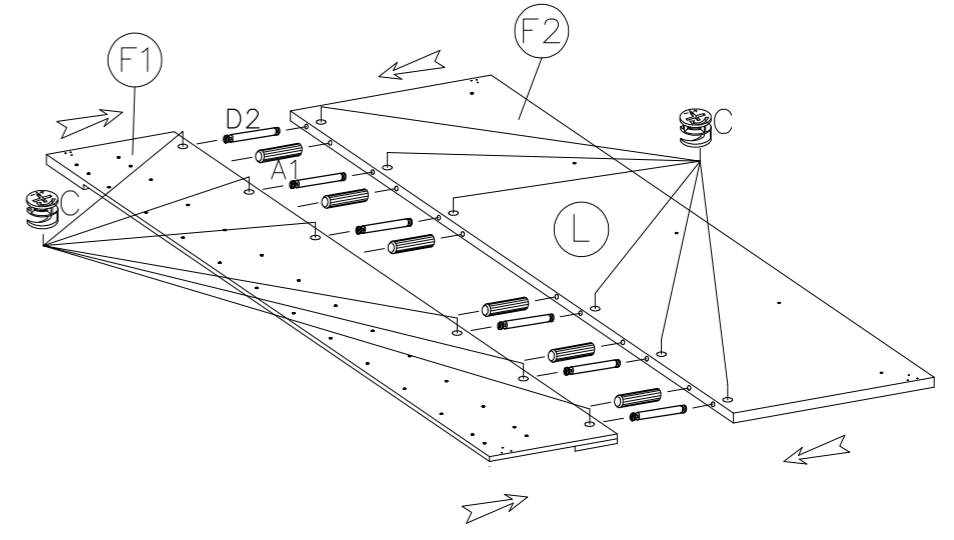
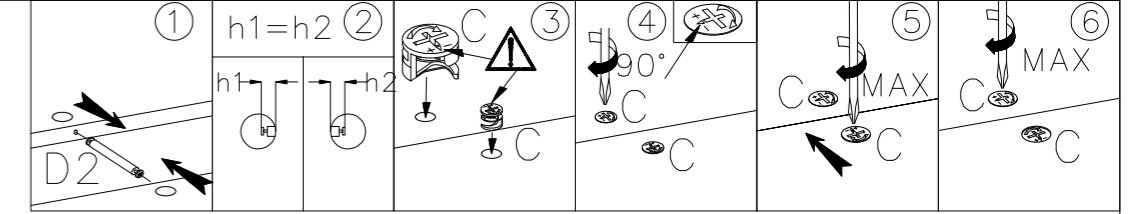

2	C1
	4

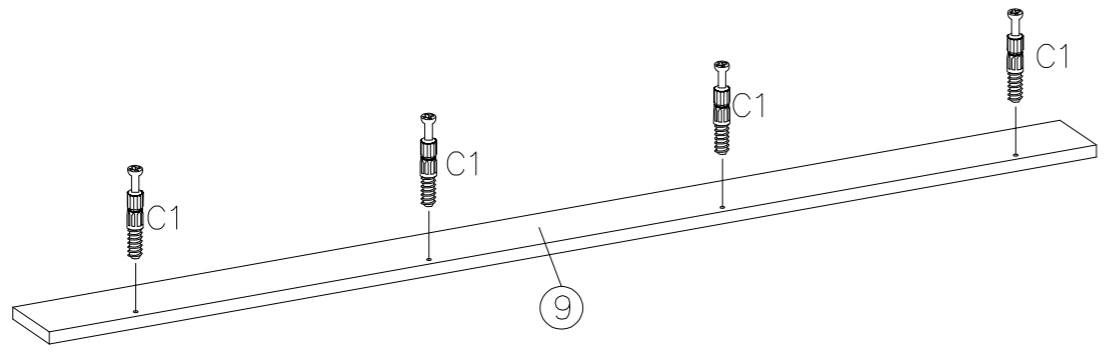
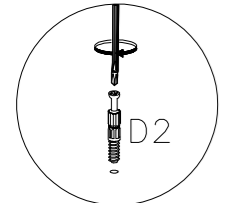

3	ø8x30mm
	A
	8

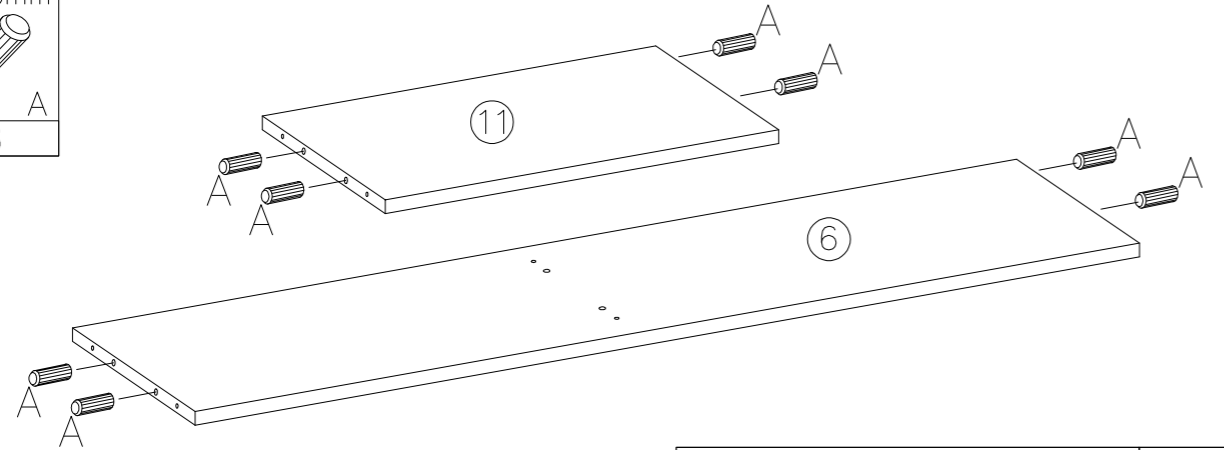

14

K5	K6	ø3.5x16mm	ø5.0x13mm	4.0x27mm	W5	4.0x20mm	3.0x13mm
4	4	P4	P23	P18		P8	P13
		12	8	10	2	4	28

